

Willkommen bei

DESAYO 

...es wird schön und warm

Ist Ihr Partner in Deutschland, Österreich und der Schweiz

Wir laden Sie ein die Innovation, die Effizienz und das eindrucksvolle Design  
unserer Produkte kennenzulernen

[www.desayo.de](http://www.desayo.de)

[www.desayo.de](http://www.desayo.de)  
[info@desayo.de](mailto:info@desayo.de)  
05 1 32/50 64 585

## Anschlüsse:

A ↓ 440÷2000:

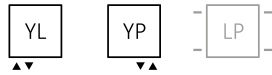

A ↓ 440÷640

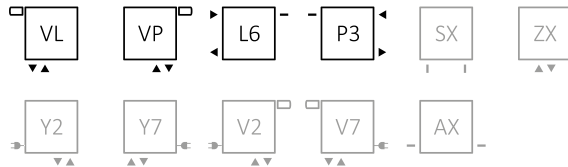

A ↓ 1800÷2000

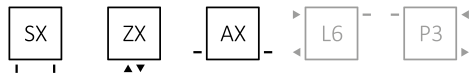

Elektroheizkörper siehe Seite 401.



## Wir empfehlen:

Set Integriertes Absperrventil für Anschluss VL, VP





Garnitur mit integrierter Blende



## Technische Daten:

Betriebsdruck: 0,8 MPa      Maximale Betriebstemperatur: 95°C

A ↓	B ↔	C1 [mm]	C2 [mm]	C3 [mm]	C4 [mm]	75/65/20°C [W]	55/45/20°C [W]	 [W]	D [mm]	E [mm]	F [mm]	 [dm³]	 [kg]	Produkt code	Konfigurations code s. 539
440	820	50	-	400	-	705	370	800	710	400	21	6,41	13,76	WGDLF044082	
440	1020	50	-	400	-	885	465	800	910	400	21	8,01	17,15	WGDLF044102	
440	1220	50	-	400	-	1061	556	1000	1110	400	21	9,60	20,54	WGDLF044122	
540	820	50	-	500	-	846	442	800	710	500	21	7,61	16,32	WGDLF054082	
540	1020	50	-	500	-	1057	552	1000	910	500	21	9,50	20,35	WGDLF054102	
540	1220	50	-	500	-	1264	661	1200	1110	500	21	11,39	24,38	WGDLF054122	
640	820	50	-	600	-	986	514	1000	710	600	21	8,80	18,89	WGDLF064082	
640	1020	50	-	600	-	1233	644	1200	910	600	21	10,99	23,55	WGDLF064102	
640	1220	50	-	600	-	1458	760	1500	1110	600	21	13,19	28,22	WGDLF064122	
1800	500	50	460	-	500	1403	717	-	360	1760	21	13,61	29,25	WGDLF180050	
1800	580	50	540	-	580	1623	830	-	440	1760	21	15,87	34,09	WGDLF180058	
2000	500	50	460	-	500	1556	802	-	360	1960	21	15,04	32,32	WGDLF200050	
2000	580	50	540	-	580	1774	909	-	440	1960	21	17,55	37,67	WGDLF200058	

## Verfügbare Größen:

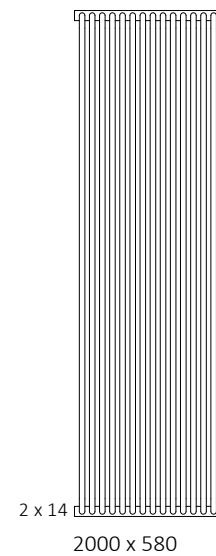
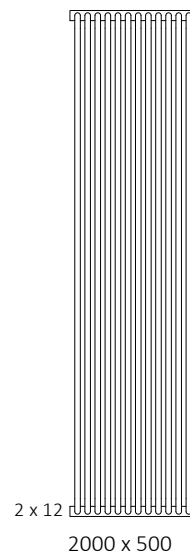
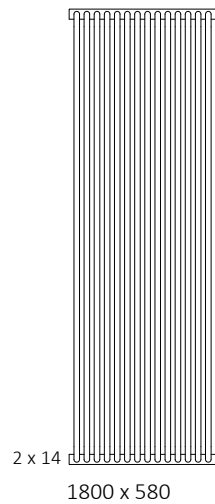
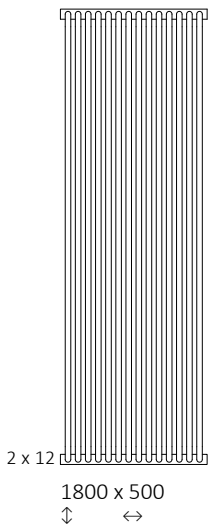
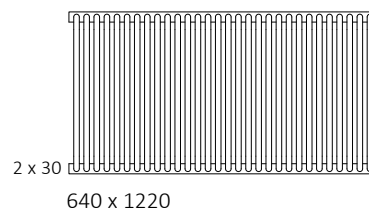
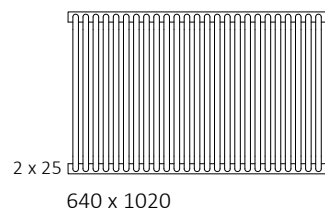
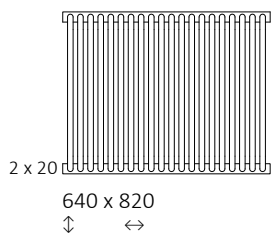
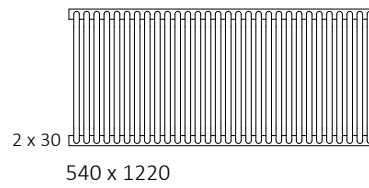
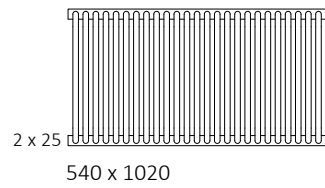
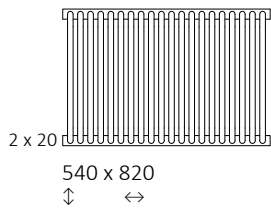
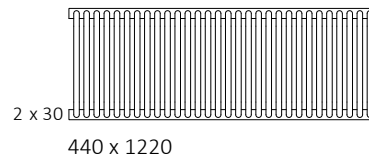
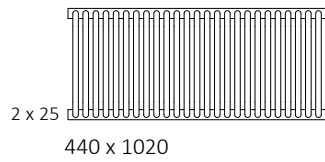
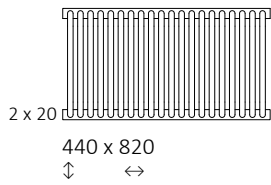

# Delfin

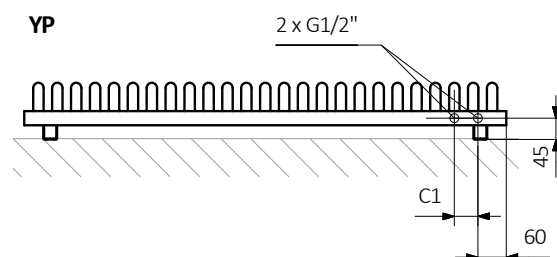
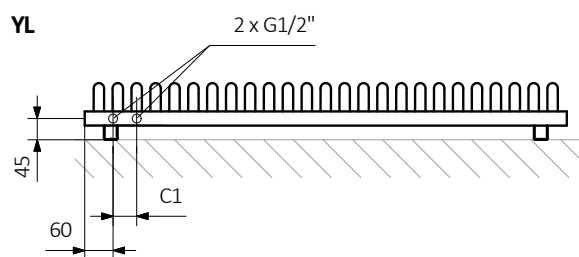
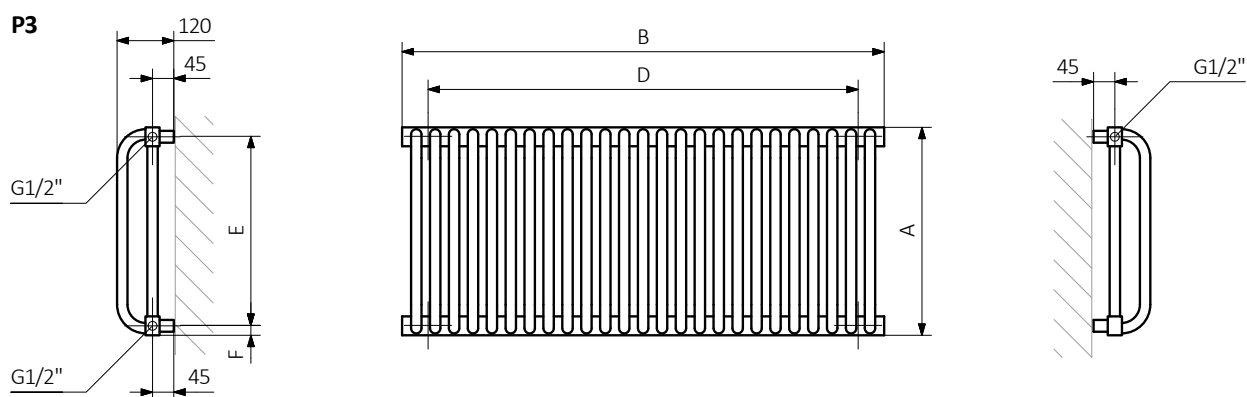
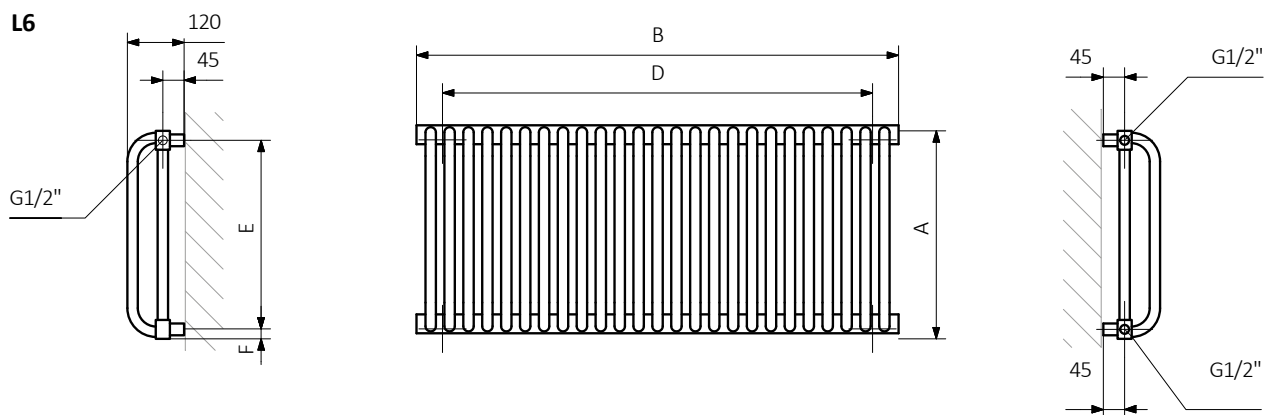

A – Höhe B – Breite C1-C5 – Anschlussabstand D – horizontaler Konsolenabstand E – Vertikaler Konsolenabstand, F – Abstand von der Achse der unteren Konsole bis Unterkante des Kollektors

**Kollektor**

**Profil:**

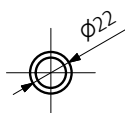
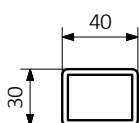

VL

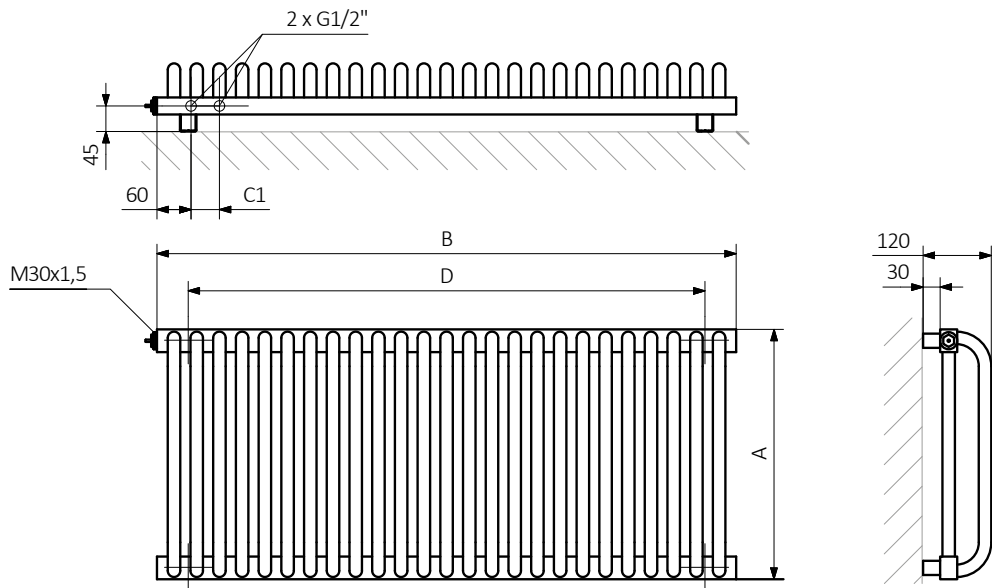

VP

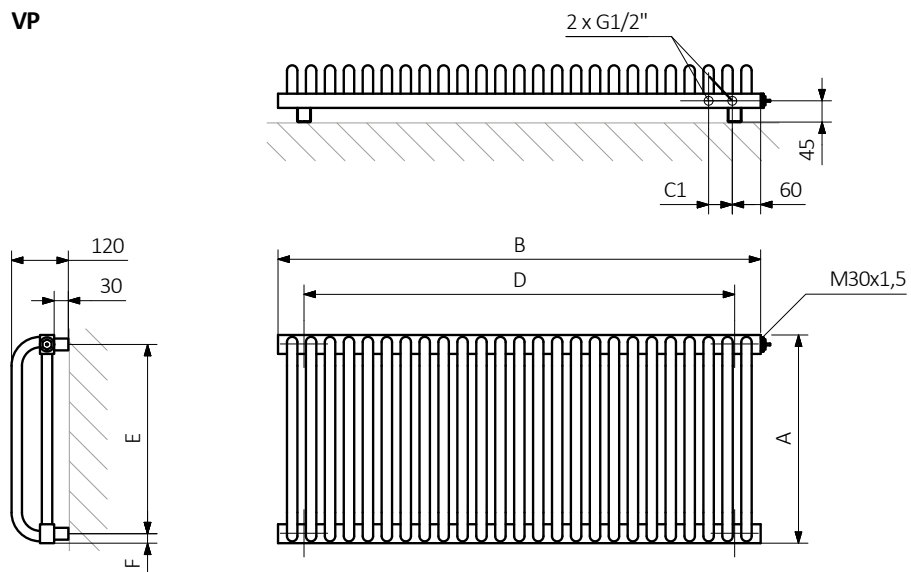

# Delfin

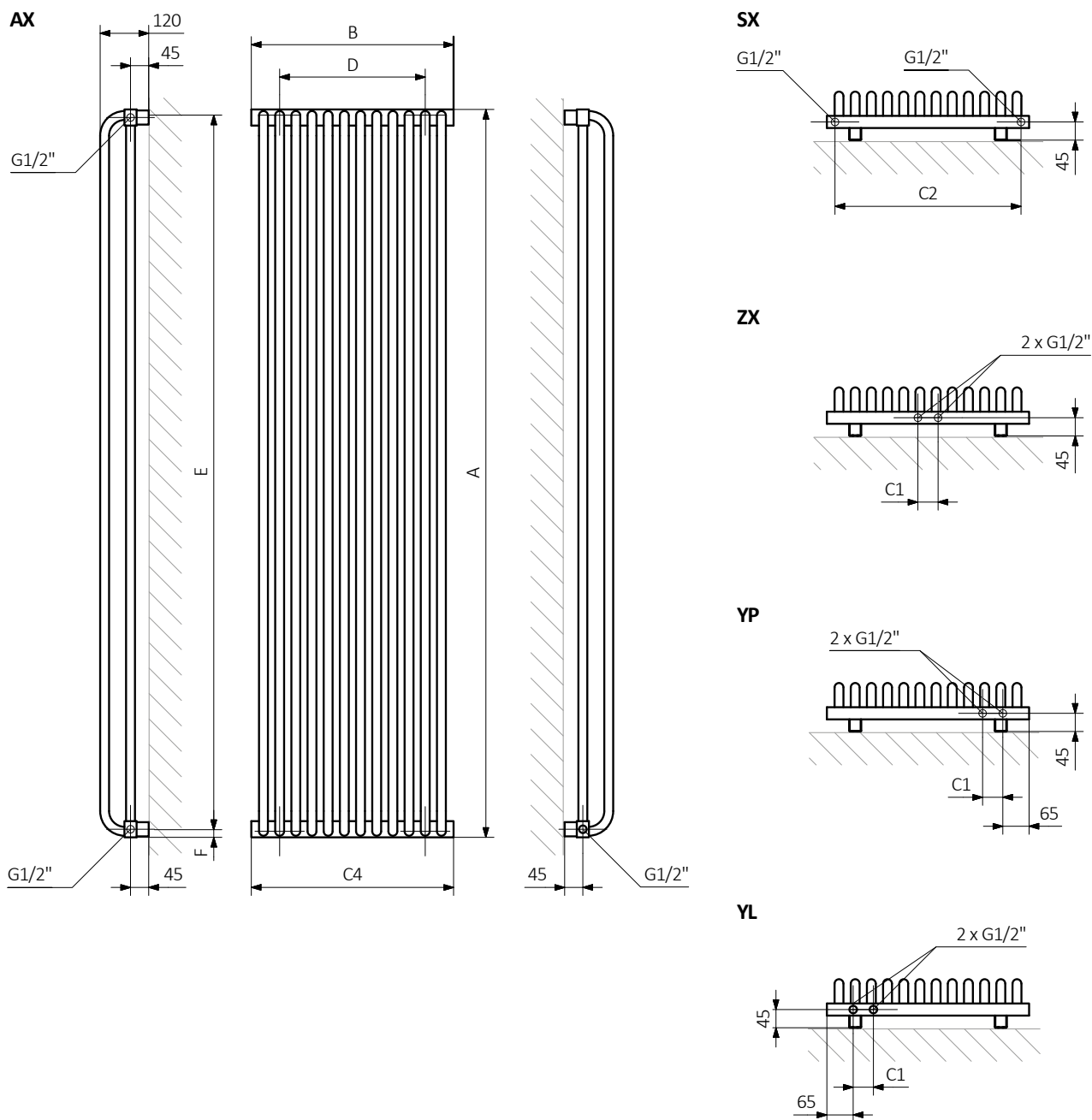

A – Höhe B – Breite C1-C5 – Anschlussabstand D – horizontaler Konsolenabstand E – Vertikaler Konsolenabstand, F – Abstand von der Achse der unteren Konsole bis Unterkante des Kollektors

**Kollektor**

**Profil:**

