

Willkommen bei

DESAYO 

...es wird schön und warm

Ist Ihr Partner in Deutschland, Österreich und der Schweiz

Wir laden Sie ein die Innovation, die Effizienz und das eindrucksvolle Design
unserer Produkte kennenzulernen

www.desayo.de

<https://desayo.de>
info@desayo.de
05 1 32 / 50 64 585

Marlin ⓘ s. 346

Marlin One ⓘ s. 350

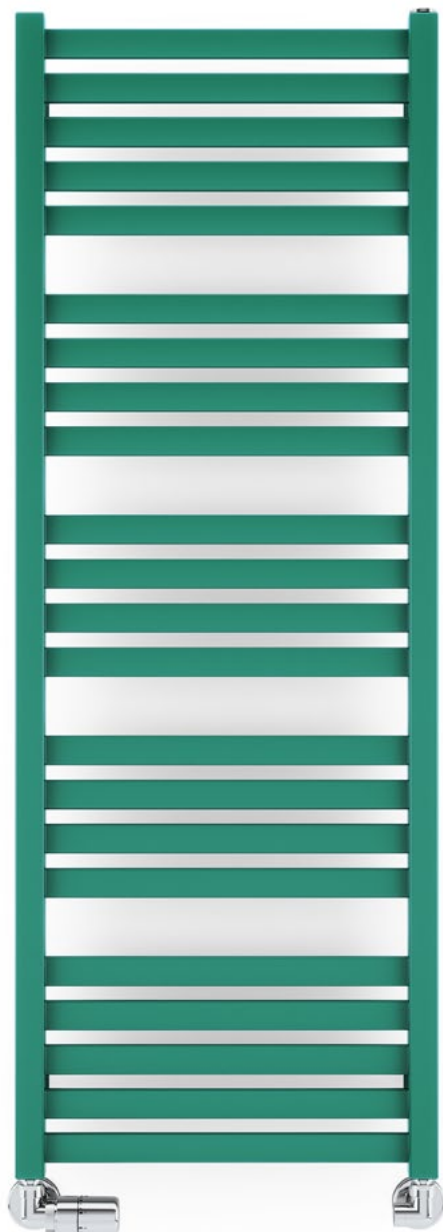

Marlin 1185↓ x 430↔ SX
Farbe: RAL 6000

Anschlussgarnitur: Set Winkeleck-Thermostatventil, links, Chrom
Set einteilige Blende, Chrom

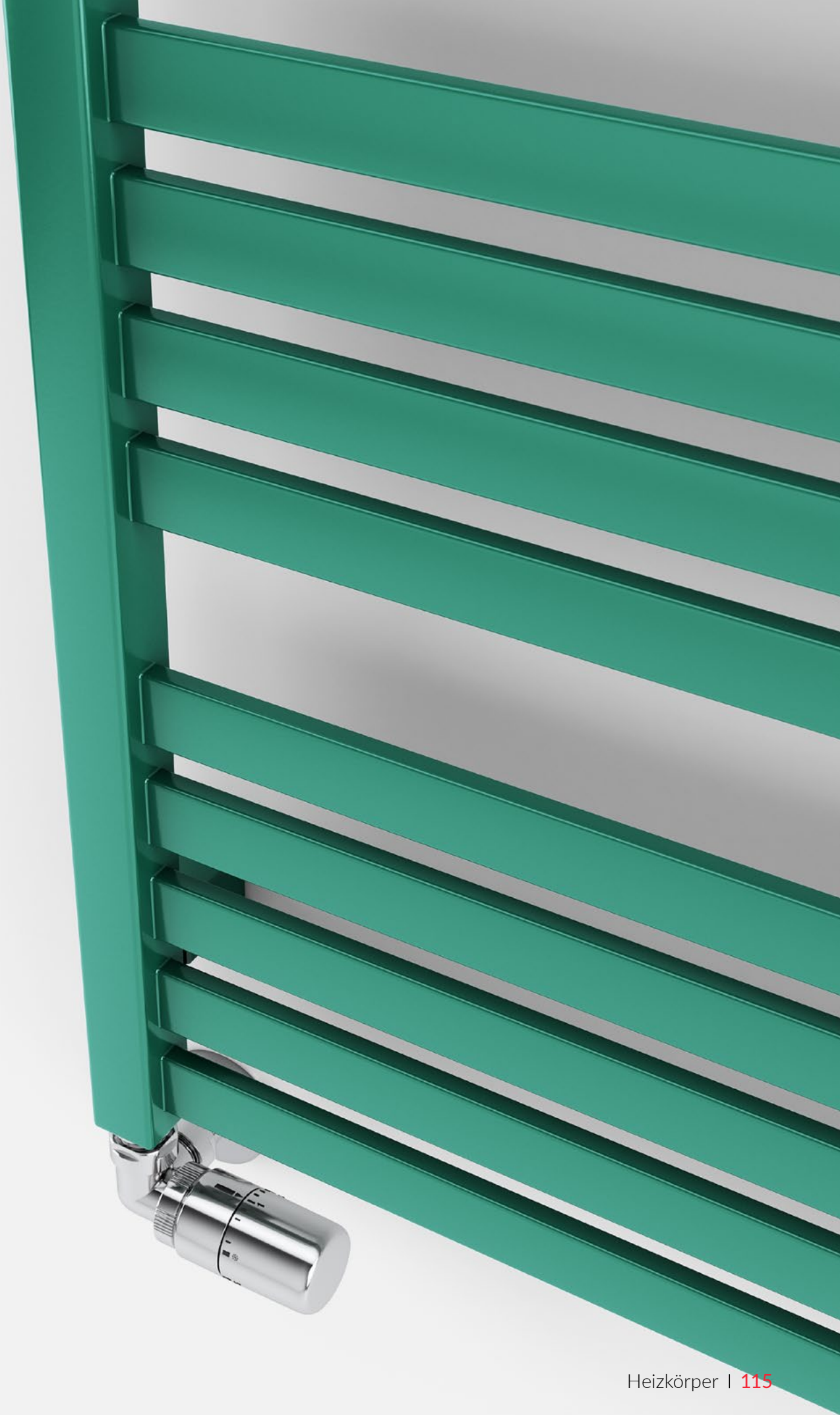

Marlin One s. 114

Heizkörper besitzt eine eingebaute Heizpatrone ONE.
Funktionsbeschreibung auf Seite 600.



projekt: *Terma*

Standard Anschlusstypen:

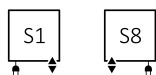

Elektroheizkörper siehe Seite 487.

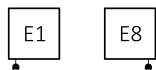

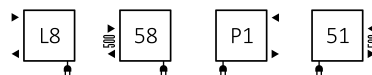

Weitere mögliche Anschlusstypen:



Technische Daten:

Betriebsdruck: 1000 kPa Maximale Betriebstemperatur: 82°C

A ↓ [mm]	B ↔ [mm]	75/65/20°C [W]	55/45/20°C [W]	 [W]	D [mm]	E [mm]	F [mm]	 [dm³]	 [kg]	Artikelnummer <small>(Konfigurations code s. 663)</small>
Pulverlack										
600	430	244	134	300	400	450	75	1,50	5,01	WZMRN060043
600	530	301	165	300	500	450	75	1,69	5,91	WZMRN060053
600	630	358	196	400	600	450	75	1,88	6,82	WZMRN060063
780	430	319	172	300	400	630	75	2,05	6,85	WZMRN078043
780	530	393	212	400	500	630	75	2,32	8,11	WZMRN078053
780	630	467	252	400	600	630	75	2,58	9,37	WZMRN078063
1185	430	467	251	400	400	1035	75	3,19	10,57	WZMRN118043
1185	530	576	309	600	500	1035	75	3,61	12,54	WZMRN118053
1185	630	685	367	800	600	1035	75	4,02	14,51	WZMRN118063
1680	430	653	351	600	400	1530	75	4,61	15,19	WZMRN168043
1680	530	805	433	800	500	1530	75	5,22	18,05	WZMRN168053
1680	630	957	514	1000	600	1530	75	5,82	20,91	WZMRN168063
Galvanische Oberfläche										
600	430	156	84	120	400	450	75	1,50	4,83	WZMRN060043
600	530	192	104	200	500	450	75	1,69	5,71	WZMRN060053
600	630	228	124	200	600	450	75	1,88	6,58	WZMRN060063
780	430	211	112	200	400	630	75	2,05	6,61	WZMRN078043
780	530	260	137	300	500	630	75	2,32	7,83	WZMRN078053
780	630	310	163	300	600	630	75	2,58	9,05	WZMRN078063
1185	430	323	162	300	400	1035	75	3,19	10,21	WZMRN118043
1185	530	398	199	400	500	1035	75	3,61	12,11	WZMRN118053
1185	630	473	237	600	600	1035	75	4,02	14,01	WZMRN118063
1680	430	462	217	600	400	1530	75	4,61	14,67	WZMRN168043
1680	530	570	267	600	500	1530	75	5,22	17,43	WZMRN168053
1680	630	677	317	800	600	1530	75	5,82	20,19	WZMRN168063

Wir empfehlen: Set Lanzen-Thermostat-Verbund-eckventil für Anschluss S1 und S8



Abdeckblende



Handtuchhalter
ZIP H 10



Verfügbare Größen:

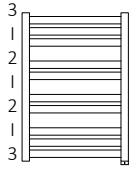

600 x 430
↕ ↔

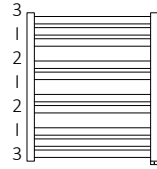

600 x 530

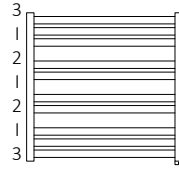

600 x 630

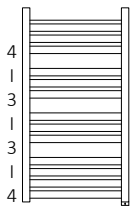

780 x 430

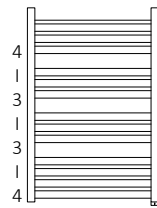

780 x 530

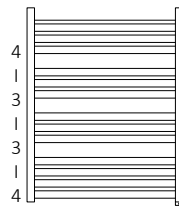

780 x 630

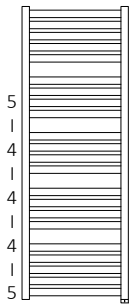

1185 x 430
↕ ↔

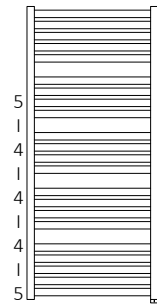

1185 x 530

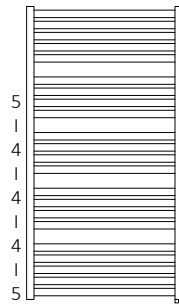

1185 x 630

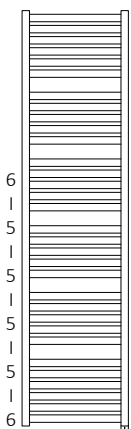

1680 x 430
↕ ↔

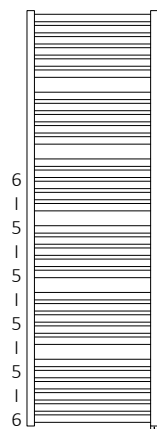

1680 x 530

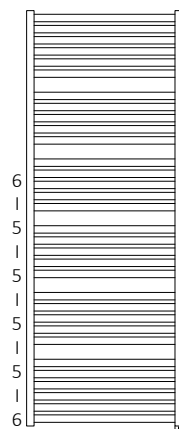

1680 x 630

Marlin One s. 114

S8

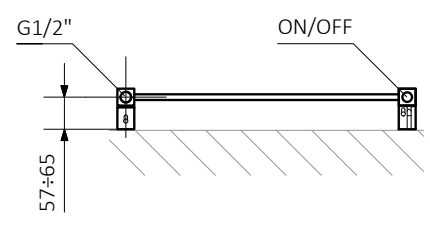

S1

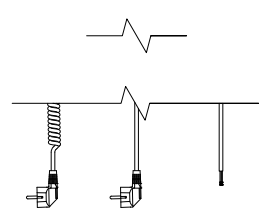
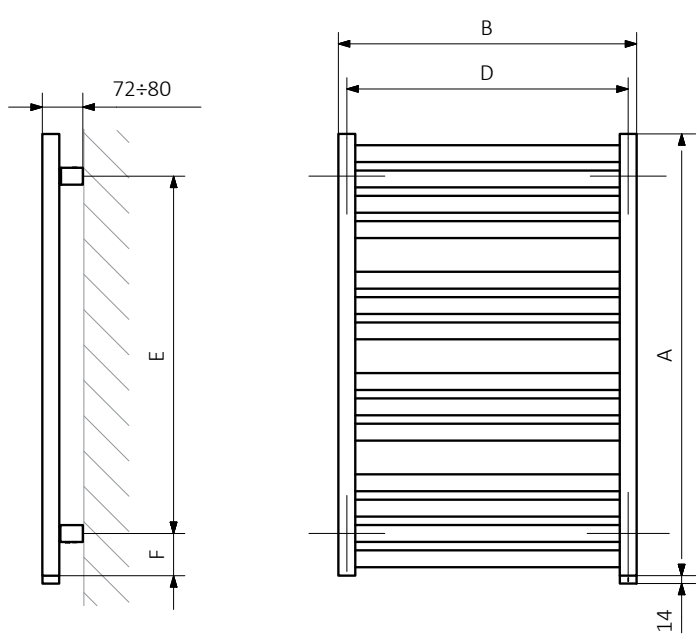
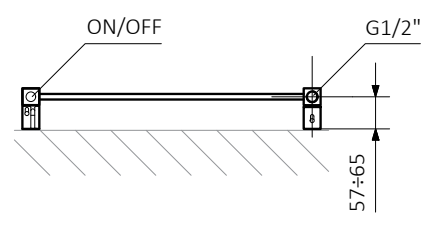

A - Höhe B - Breite C1-C5 - Anschlussabstand D - horizontaler Wandhalterungsabstand E - Vertikaler Wandhalterungsabstand F - Abstand von der Achse der unteren Wandhalterung bis Unterkante des Kollektors

Kollektor:

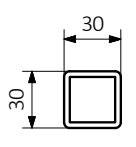

Rohr:

